

Readers

Dear customers, your use of the broadcasting company speaker series. We would like to extend my heartfelt thanks to all of the Company manufactured products have been tested before, the commitment to keep its quality. Loud - speakers broadcast Pan-for hotels, commercial buildings, supermarkets, schools, leisure and entertainment venues, is your ideal choice. For your installation, commissioning and use of this product, the installation please read this note.

Safety Tips

- Please be sure to use the former reading detailed notes.
- Really pay attention to this manual and a safety with the important warning.
- Recommend that you keep this manual for future reference.

Common warning signs and security

The manual shown warning signs and security is to prevent the improper operation due to personal injury arising from the loss of property, please read before using this product must understand that this manual security symbols and Warning to indicate fully aware of potential risks.

 Warning Such as the inappropriate use of staff will cause injury, death and property damage.
--

When installed loudspeakers

- Definitely will not be allowed to speakers and any exposure in the rain-wet or water, may be inconsistent with , or fire.
- Restricted by the provisions of the speakers on the voltage, such as the use of high voltage may cause electric shock or fire disaster. Is no pruning, distorted, or replacement of damaged wires.
- Avoid instability in the installation or set up speakers, such as shaking the table or flat surface , the speaker can avoid falling caused personal injury or property damage.
- Speakers will be installed in support of the speaker or the weight of a solid shelf. Speaker swap can be avoided caused personal injury or property damage.
- Wet hands must not be admitted into or plugs, may lead to electric shocks.
- The allocation of plugs, make sure that pull plugs, rather than pull wires. The use of a damaged power line of machinery may cause fire or electric shock.
- Mobile speaker, you plug the prior allocated. If the speaker and plugs may be moving together will cause fire or electric shock. For plugs, identified as plugs for grip.
- Will not be allowed to speakers on the vent cover. May cause internal heating caused by the fire.
- Avoid speakers installed in the humidity or dust, direct contact with the sun, from the near-electric, or smoke or steam, may cause fire or electric shock.

itc

Pendant Speaker



T-200D/200DW

OWNER'S MANUAL

Dimension

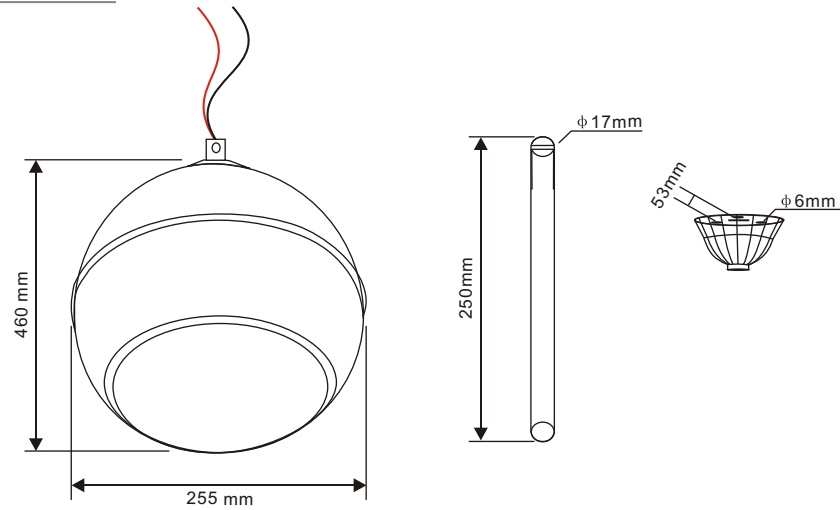

T-200D/200DW

Specifications

Model	T-200D	T-200DW
Power Taps@100V	15W	
Power Taps@70V	7.5W	
Impedance	Black:Com Red:670 Ω	
SPL(1W/1M)	86dB	
Freq Response	100-16KHz	
Dimensions	255×460 mm	
Weight	2.6 Kg	

Installation

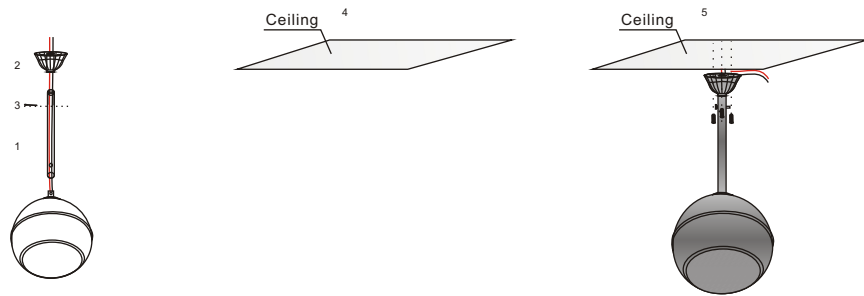

1. Speaker line will pass through parts, and accessories screws will be fixed with a good speaker

2. Speaker weight of 2.6Kg, must be chosen by our body strong and avoid unstable speakers falling or injuries. Open spaces in the ceiling for the 10mm.

3. Flower horn plate wear line. Measurement tools used to measure the size of the speaker hole and the distance between pore spaces, and selected in line with the screw hole.

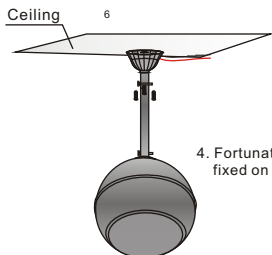

4. Fortunately, the ceiling will be fixed on the speaker.

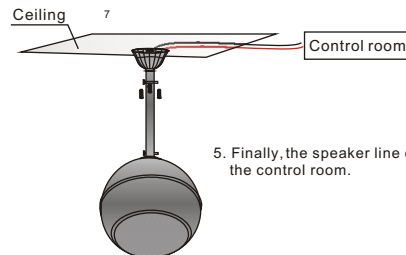

5. Finally, the speaker line connected to the control room.

Labels Stickers

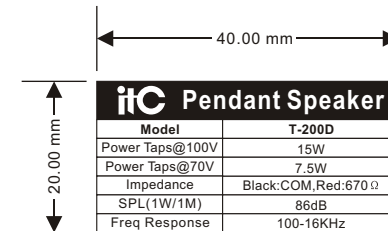

T-200D

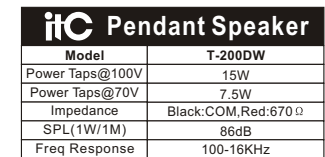

T-200DW